

This instrument consists of an organic pollution monitor that employs ultraviolet absorptiometry; it is an automatic water quality analyzer that uses a dual-wavelength technique to measure ultraviolet (UV) and visible light (VIS) absorbance. In the measurement unit, UV and VIS light is directed at sample water flowing down from a 10mm diameter nozzle.

The analyzer includes the capability to convert the measured absorbance values to COD values.

Features

Flowing-down water method

This model measures absorbance by directing light at sample water flowing down from the nozzle (water column), without using a measurement cell window, which can come into contact with sample water. This, in theory, can eliminate the measurement errors resulting from the contamination of the cell window.

A new optical system is adopted.

A new light quantity feedback system keeps the amount of light constant, which ensures that the unit provides stable measurements. The new system eliminates the need for a heater to stabilize the light quantity that was used in the previous model. These factors help to significantly reduce the amount of power consumed by the instrument (approximately 75% less than the previous model).

Correction for the effects of turbidity

Since the instrument measures absorbance by applying a VIS light, it can make correction to compensate for the effects of turbidity.

Inner wall cleaning of the sample water supply nozzle

The instrument performs the automatic cleaning of the inner wall of the nozzle by moving the wiper system vertically on a periodic basis. This enables a water column to be created by the flowing-down sample, in order to be consistent to ensure stable measurements.

Splash guard

A splash guard has been newly installed to protect the optical unit from splashing during cleaning or when a sample is introduced (patent pending).



Steam-proof design

Steam forms when the sample temperature becomes higher than the ambient temperature, which may interfere with the analysis. As a solution to this problem, this instrument is equipped with an exhaust fan system that introduces outside air to eliminate the effects of steam on the analysis.

Enhanced data processing support functions

In addition to the analog output of measured values, this device is also equipped with output options including the writing of data to USB memory and digital communication interfaces. These functions can be effective in data processing, such as in pollutant load calculation by the host system.

Standard specifications

Product name	: Organic Pollution Monitor
Model	: OPM-1630
Measurement method	: Dual-wavelength absorptiometry (ultraviolet [UV] 254nm/visible light [VIS] 660nm)
Measurement cell	: Flowing-down water method; water column diameter; ϕ 10mm
Cleaning method	: Wiper motor system for automatic nozzle cleaning
Measurement range	: UV absorbance; 0 – 2.5Abs (The transmission output range can be adjusted in 0.1Abs increments within a range of 0.5 – 2.5 Abs.)

Range switching : The measurement range (transmission output range) for absorbance can be switched manually, automatically, or by external control signals.
(The measurement range for UV and VIS are also switched simultaneously with that for UV absorbance.)
Manual; Any of 4 ranges can be selected.
Automatic; Any range can be selected between those assigned to ON contact outputs. (Up to 4 ranges can be assigned.)
External control signals; The currently selected range is switched into any of those that are assigned to contact inputs. (Up to 3 ranges can be assigned.)

Minimum indication : 0.001Abs

Ambient temperature / humidity : -5 – 40°C, 95%RH or less (no condensation)

Sample conditions : Temperature, 0 – 45°C (no freezing)
pressure, 0.02 – 0.3Mpa
flow rate, 10 – 15 L/min. (Measurement flow rate; Approx. 8 – 10L/min.)

Zero calibration : Distilled water, pure water, or activated carbon filtrate water is circulated by using a calibration kit.
(Calibration kit; Optional feature)
(City water can also be used only if the quality is not so strictly controlled.
Quantity of city water required:
approx. 8 – 10L/min. [City water piping: optional feature, needs to be specified by customer when placing an order])

Span calibration : A potassium hydrogen phthalate solution is circulated by using a calibration kit.
(Calibration kit; Optional feature)
Temperature compensation range for the span calibration solution; 0 – 45°C

Transmission output : 4 – 20mADC, 3 channels; load resistance: 600Ω or less, isolated (non-isolated between transmission outputs)
(Any 3 of the following can be selected; UV absorbance, VIS absorbance, UV-VIS absorbance, COD conversion value, and sample temperature.)

Contact output signals : Power cut-off signal, c contact (NO/NC) output
Alarm signal, a contact (NO) output
Any 3 of the following items can be assigned to the 3 contact outputs.
(Selected items can be overlapped.)
1. Under maintenance
2. Under cleaning
3. Range switching signal (R1, R2, R3, R4, but no output for R1)
4. Batch alarms: Measured value upper limit alarm, Lamp error (UV, VIS), No sample, Wiper drive motor error, and Sample temperature error)
* Up to 3 range switching signals can be assigned.

* Any of the 5 batch alarm items can also be assigned.

Contact capacity; 30VDC, 0.1A or less, 125VAC, 0.1A or less (resistance load)

Contact input signals : No. of input; 2 contacts; the following input signals can be assigned to contact inputs.

Any 2 of the following can be assigned: "Cleaning start signal," "Range switching signal R1," "Range switching signal R2," "Range switching signal R3," and "Range switching signal R4" (suitable when range switching is remotely controlled).

No-voltage contact input signal; ON resistance; 50Ω or less; short-circuit current; maximum of 5mA; open voltage; 24VDC; make time; 0.1sec. or less

Digital communication output : Optional feature
(2 selections are available for digital communication output; communication output RS-485 or output to USB memory for data recording.)

Wetted part materials : Hard vinyl chloride, flexible polyvinyl chloride, SUS316, acryl, EDPM, and FPM

Construction : IPX3

Weight : Approx. 31kg

Power requirements : 100VAC±10%, 50/60Hz

Power consumption : Maximum; 50VA, average; 10VA

Performance

Repeatability : Within ±2%FS (by calibration solution)
(Note; Within ±5.0%FS for ranges 0 – 2.5Abs)

Linearity : Within ±2%FS (by calibration solution)
(Note; Within ±5.0%FS for ranges 0 – 2.5Abs)

Zero drift : Within ±2%FS/week

Span drift : Within ±2%FS/week

Response rate : Within 60sec. for a 90% response
(When the flow rate from the sample inlet is 8 – 10L/min.)

Operating principle

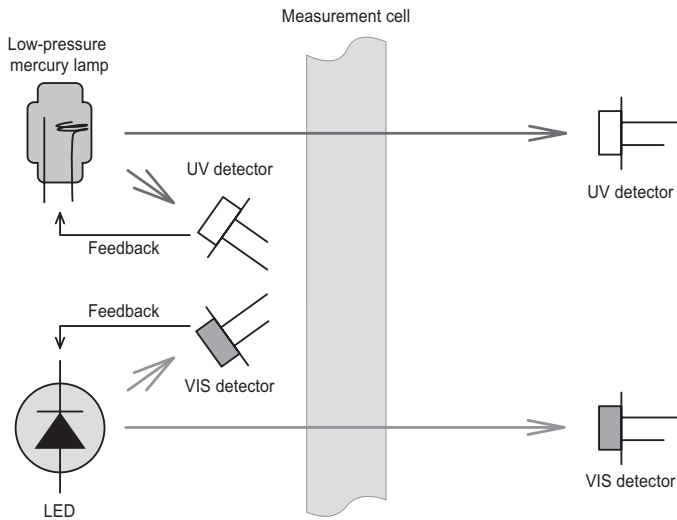

The OPM-1630 uses the dual wavelength technique to measure pollutants. This technique employs 2 highly stable sources of light, UV (ultraviolet) and VIS (visible light).

When a UV light source is applied, a 254nm emission line from the ozone-free low-pressure mercury lamp is used. In VIS detection, a pulsating 660nm LED is irradiated as the light source to measure turbidness.

There are 2 ways to converting instrument output to COD values. The first consists of using the correlation between UV absorbance (A_{UV}) and the COD manual analysis value. The second method involves using the correlation between the difference of the "UV absorbance (A_{UV}) minus VIS absorbance (A_{VIS})" (value given by the expression $A_{UV} - \alpha \times A_{VIS}$ to eliminate the effect of suspended solids) and the COD manual analysis value.

α = Correlation factor (Freely specified value of 0.00 – 9.99; default value of 1.00)

Terminal connections

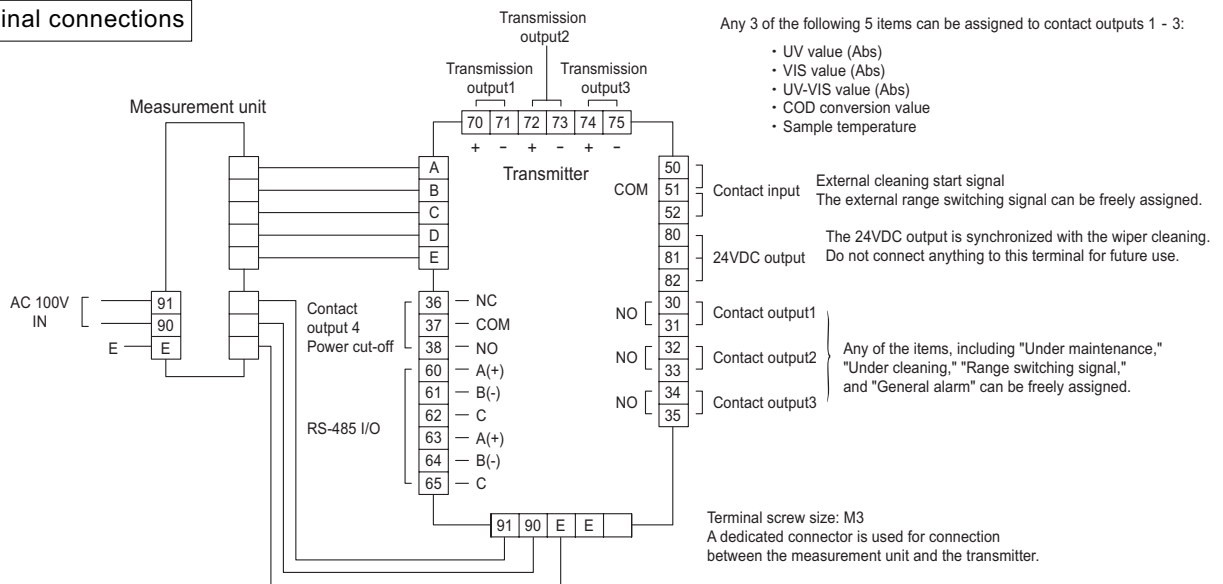

Measurement system diagram

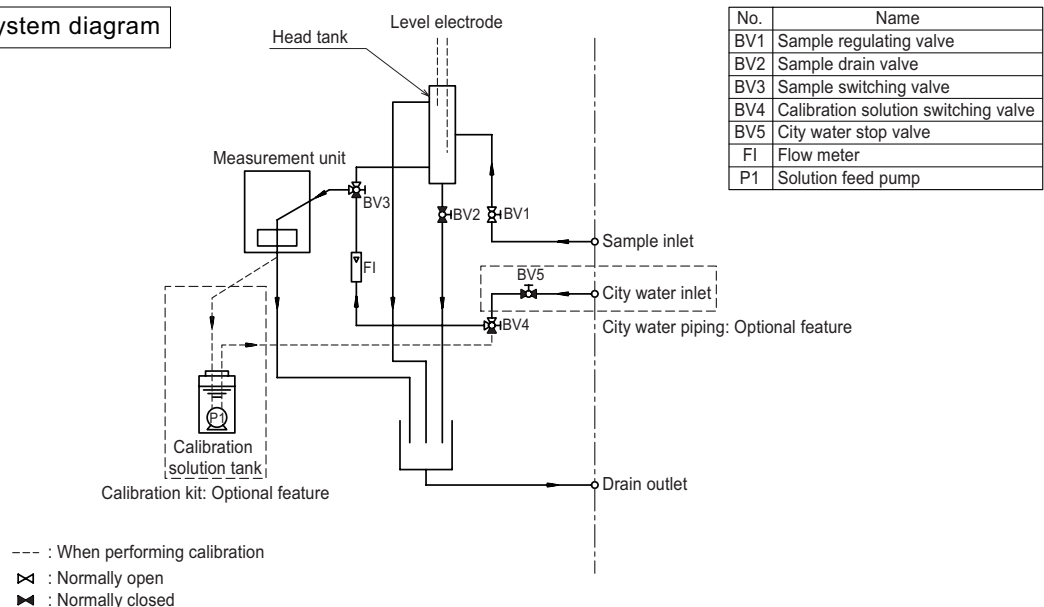

Dimensions

Unit : mm

- 100VAC power supply specifications (standards)

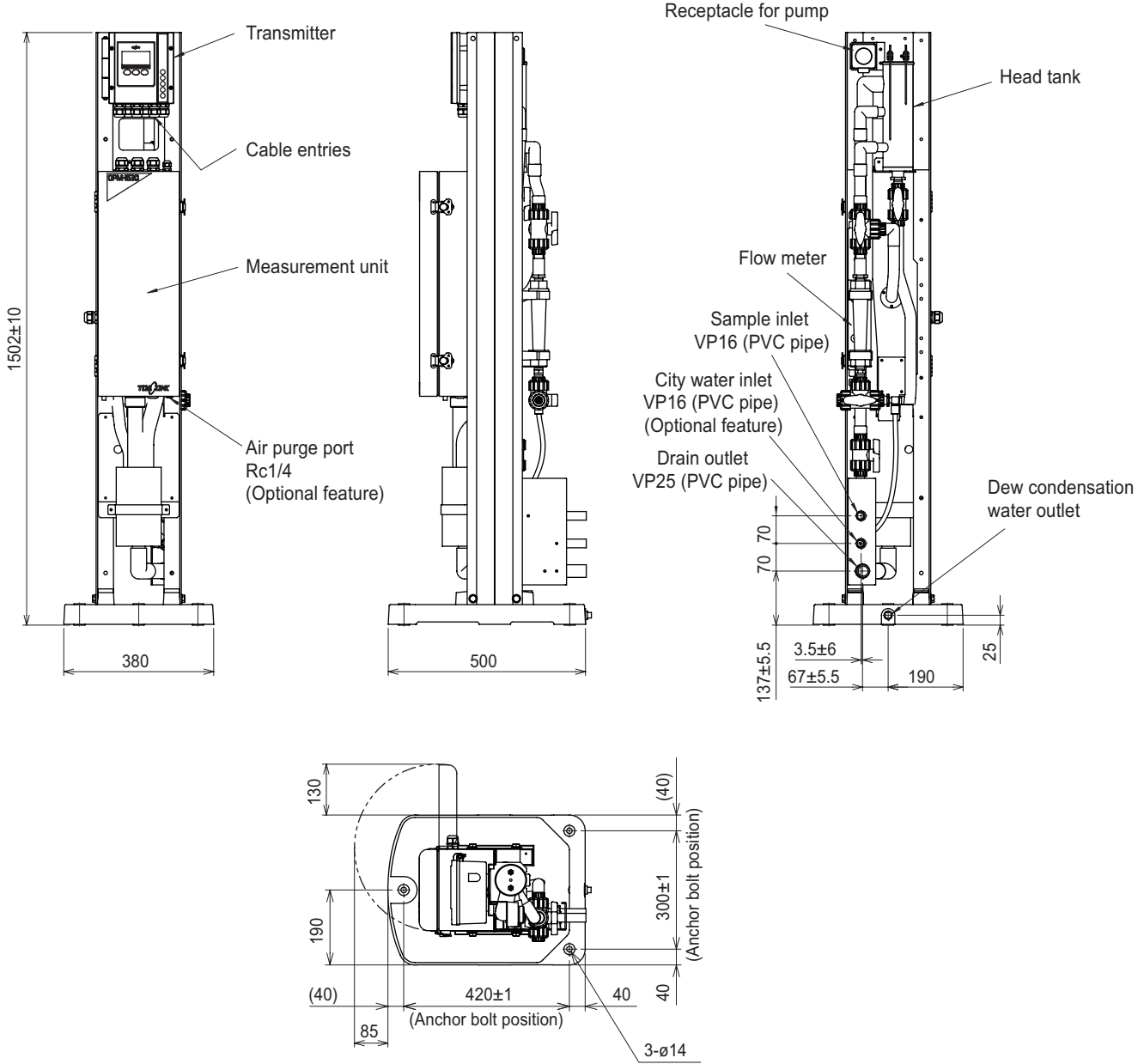

- Custom specifications other than a 100VAC power supply
(An optional power conversion unit is installed on the back of the unit.)

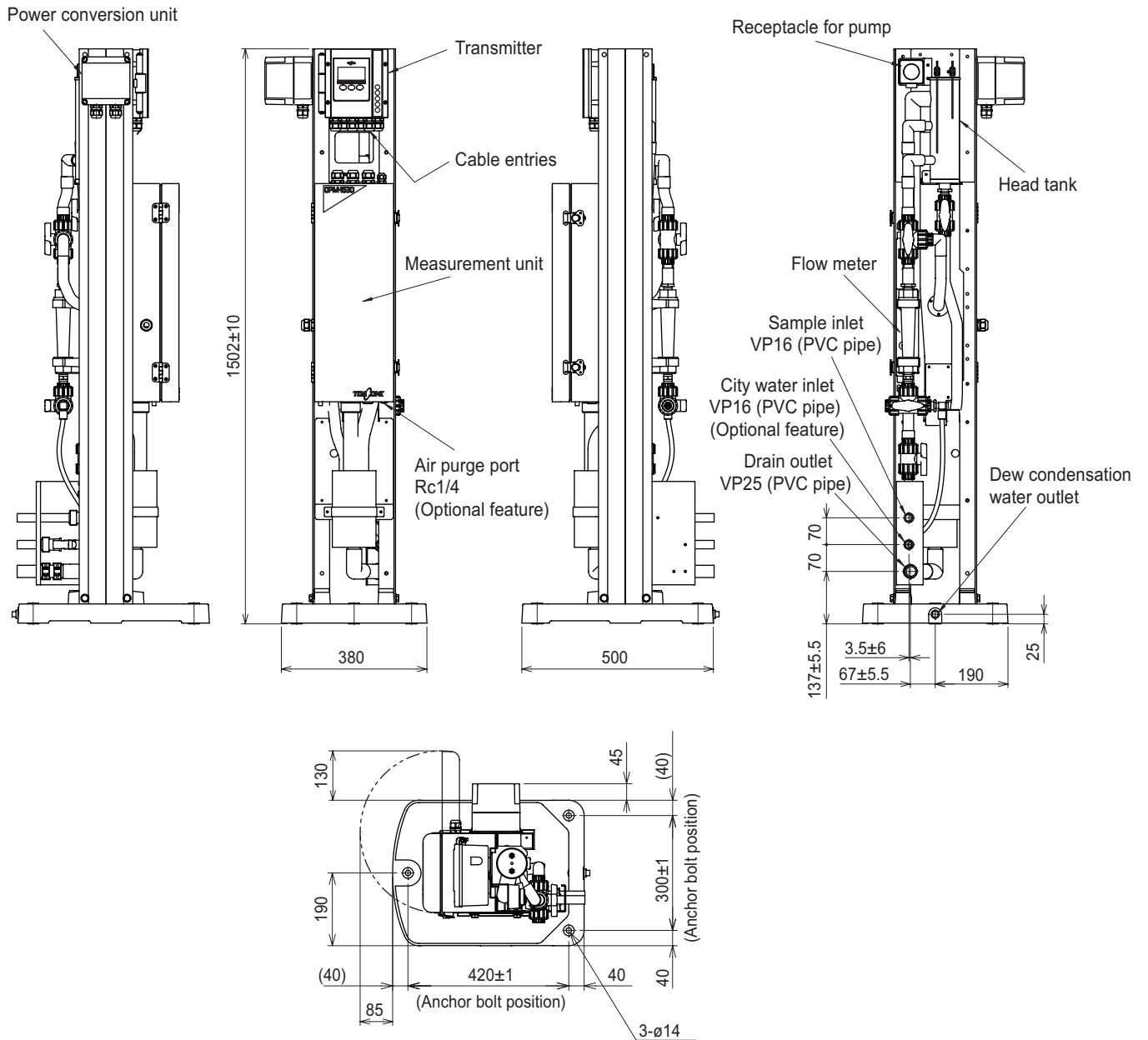

Product code

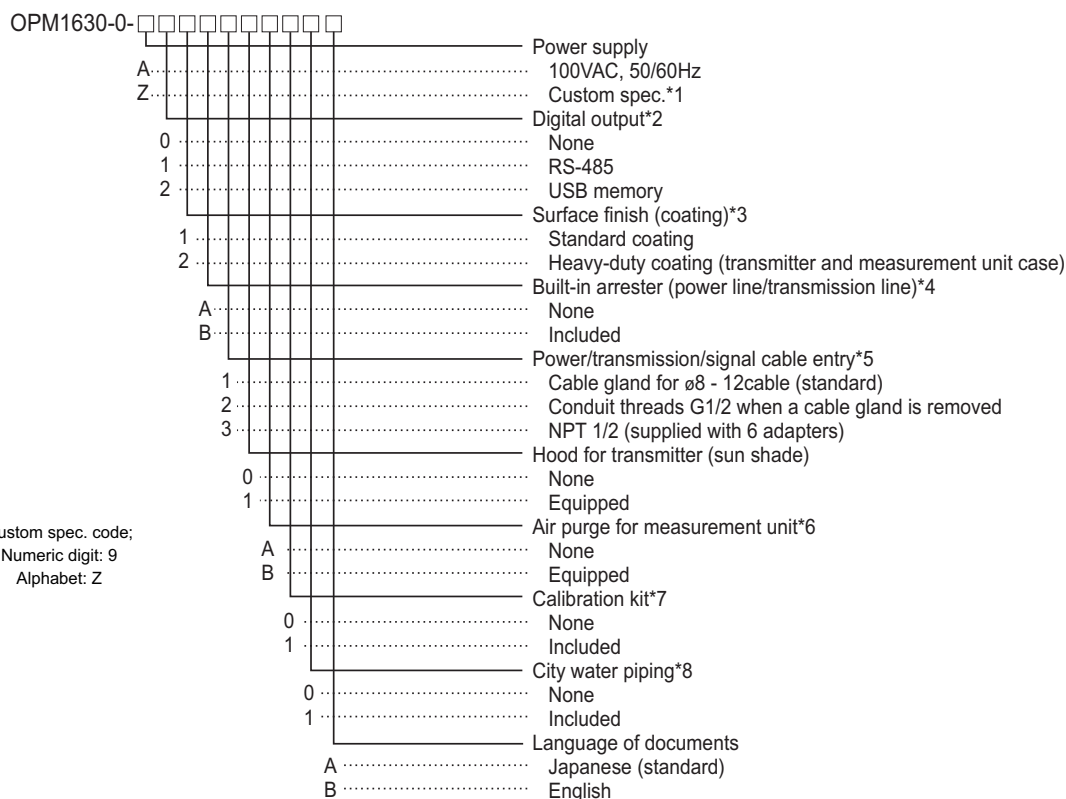

- *1. If you are using a supply voltage that is not 100V, install a step-down transformer on the aluminum self-standing frame.
- *2. A 4 – 20mADC analog output comes standard.
- *3. The transmitter is finished in melamine resin coating as standard, while the measurement unit is finished in acrylic resin coating as standard. If the transmitter has a heavy-duty coating, the measurement unit case has the same.
Heavy-duty coating: Epoxy primer and second coat; polyurethane resin topcoat
Average film thickness: Greater than 100µm; glossiness: G80
- *4. Ceramic surge arresters (simple type) are attached to the power and transmission lines.
- *5. There are 6 cable entries mounted with ø8 – 12cable glands for the transmitter. When a cable gland is removed, G1/2 conduit threads appear.
When NPT1/2 cable entry is requested, 6 adapters (SUS316) are supplied; replace the necessary number of cable glands with adapters. If some entries are not used for conduit, please leave the cable glands for sealing.
- *6. In a corrosive gas environment, instrument air (dried, dust-free air) can be supplied to protect the insides of the measurement unit from corrosion (connection port; Rc1/4).
- *7. A calibration kit is used when performing zero/span calibration by using a zero water/span calibration solution. The calibration kit supplied with the conventional model (OPM-423A) can also be used.
- *8. Since city water has some absorbance, use city water only after you have ensured that it would not cause a problem if used in zero calibration.

Note:

1. An exhaust fan system to remove steam in the measurement unit comes standard.
2. The measurement unit has a protection code rating of IPX3, and the ambient temperature must be -5 – 40°C. When installed outdoors, protection from rain and sun light is essential. For details, please contact one of our sales representatives.
3. The related equipment to be combined can be purchased separately if necessary.
Items to be specified when ordering a sampling pump: Manufacturer name, supply voltage (100V AC or 3-phase 200V), frequency, pump head (vertical distance from the water surface to the installation surface [m]), pipe grade/length, and pipe diameter (preferred value)
For a self-suction pump, the suction head (vertical distance from the water surface to the pump [m]) shall also be specified.

Recommended sampling pumps

Item code	Product name	Model	Voltage	Frequency	Output	Manufacturer name
125B642	Submerged pump	P717 5.4S	100VAC	50Hz	0.4KW	EBARA CORPORATION
125B643	Submerged pump	P717 5.75S	3-phase 200V	50Hz	0.75KW	EBARA CORPORATION
125B644	Submerged pump	P717 6.4S	100VAC	60Hz	0.4KW	EBARA CORPORATION
125B645	Submerged pump	P717 6.75S	3-phase 200V	60Hz	0.75KW	EBARA CORPORATION
125B637	Self-suction pump	MP2N-0021R	100VAC	50Hz	0.2KW	TERADA PUMP CO., LTD.
125B638	Self-suction pump	MP2N-0021TR	3-phase 200V	50Hz	0.2KW	TERADA PUMP CO., LTD.
125B639	Self-suction pump	MP2N-0021R	100VAC	60Hz	0.2KW	TERADA PUMP CO., LTD.
125B653	Self-suction pump	MP2N-0021TR	3-phase 200V	60Hz	0.2KW	TERADA PUMP CO., LTD.

Installation diagram

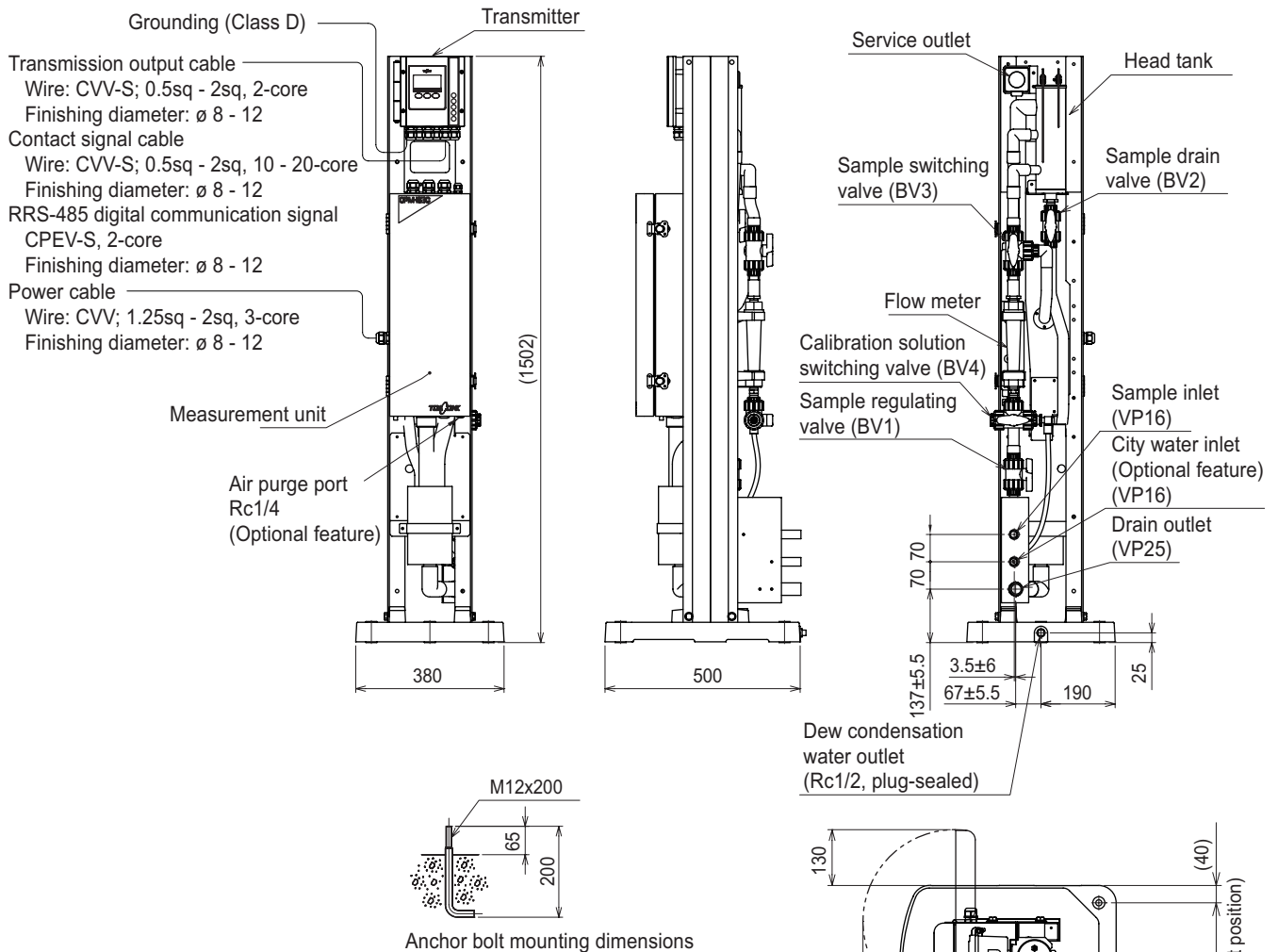

Notes:

1) Sample water system piping

Make sure that the drain pump and its piping are installed in accordance with the piping system diagram.

Sample inlet: VP16 (PVC pipe)

Drain outlet: VP25 (PVC pipe)

Adjust the supply flow rate within the range of approx. 10 – 15L/min.

Remarks: If the sample contains large amounts of suspended solids, install a strainer upstream from the sampling pump.

When installing piping, make sure to note the following:

- Make sure that the sample supply pressure is 0.02 – 0.3MPa (when the stop valve at the instrument inlet is “closed”).
- Select a 16A-hard PVC pipe or braided hose (PETP) for a sample pipe.
- Install a union, etc., on a sample pipe so that the inside can be cleaned out easily.
- Make sure that the pipe is installed downward so that the sample water flows down by itself. Also, make sure that the pipe length is 4m or less and that the end of the pipe is open to the atmosphere.
- Have a sampling pump ready.

Install a sampling pump so that the head of the pump is beneath the water, taking water level fluctuations into consideration. In addition, make sure that the suction opening is well above the bottom of the water, in order to avoid the intake of suspended material such as sludge and stones.

2) City water piping (PVC pipe with a connection diameter of VP16) (optional feature)

- Use a 16A-hard PVC pipe or a braided hose (PETP).
- When the pipe is likely to freeze in winter, provide thermal insulation.
- When using city water, install a city water receiving tank and pressure pump, as directly connecting city water to the instrument is prohibited. For your information, a city water pressure device—the combination of a receiving tank and a pressure pump all-in-one—is also available on the market.

Important: Before connecting the city water pipe, be sure to remove dirt, burrs, and chips from inside the pipe.

- If you use activated carbon filtrate water as a zero calibration solution, install a zero water filter outside the instrument.



DKK-TOA CORPORATION

Overseas Sales Division:
DKK-TOA Corporation
29-10, 1-Chome, Takadanobaba, Shinjuku-ku,
Tokyo 169-8648 Japan
Tel : +81-3-3202-0225 Fax : +81-3-3202-5685



CAUTION

Please read the operation manual carefully
before using products.